

SR108M - KR108M

PORTAVALIGIA SPECIFICO - SPECIFIC CASE HOLDER  
PORTE-VALISE SP CIFIQUE - SPEZIFISCHER KOFFER-TR GER  
PORTA-EQUIPAJE ESPECIFICO

**PIAGGIO MP3 2006**  
**125/250cc**

ISTRUZIONI DI MONTAGGIO - MOUNTING INSTRUCTIONS  
INSTRUCTIONS DE MONTAGE - BAUANLEITUNG - INSTRUCCIONES DE MONTAJE

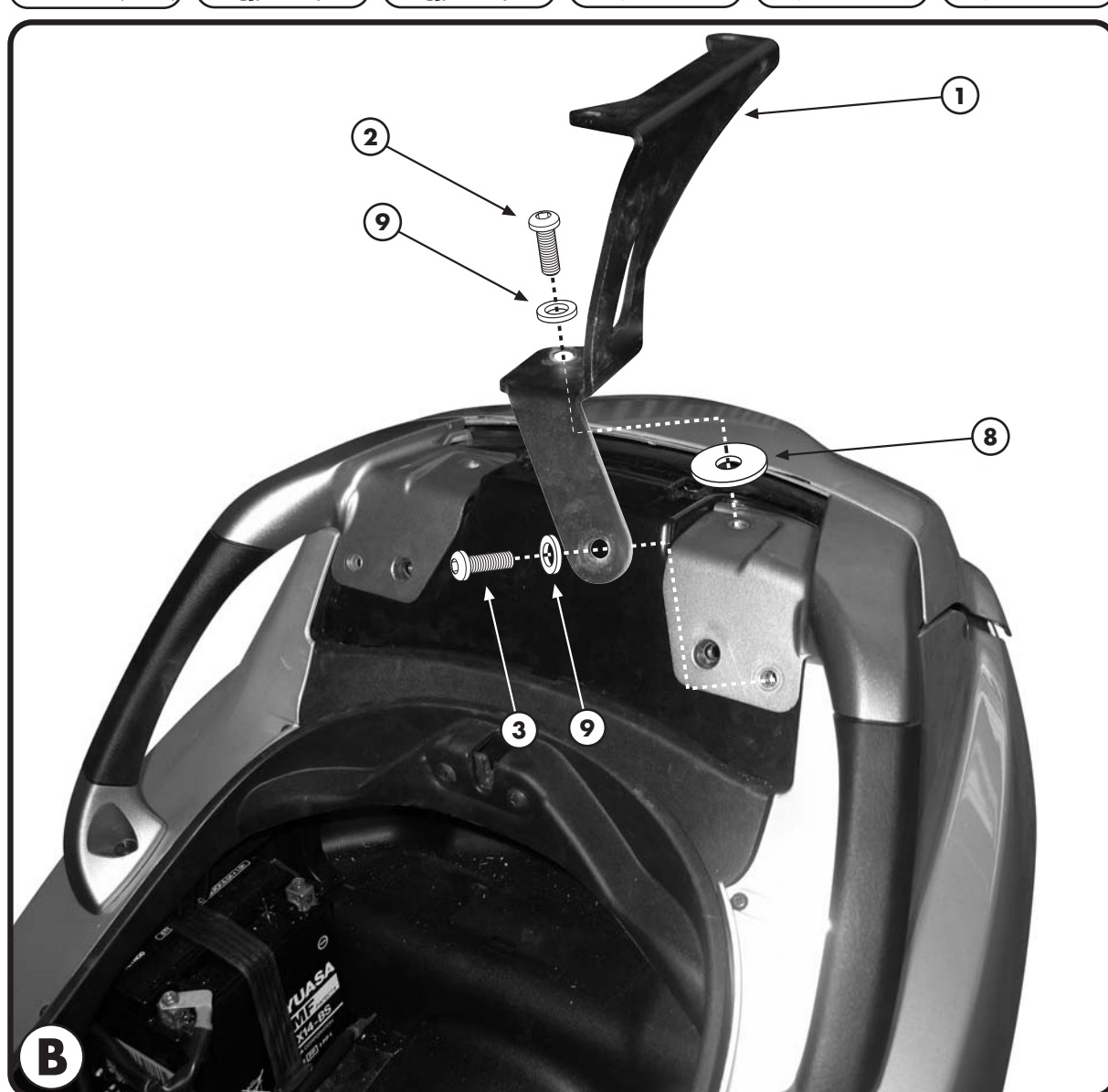
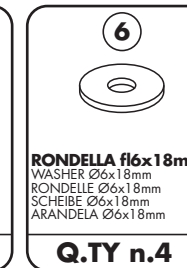
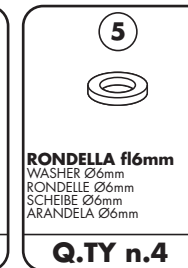
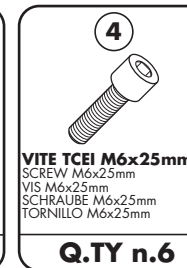
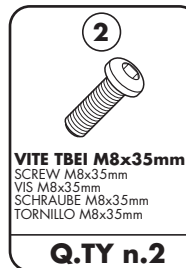

**ATTENZIONE**  
PESO MASSIMO SOPPORTABILE 6Kg.

**WARNING**  
MAX. LOADING OF THE CARRIER 6Kg.(13lbs)

**ATTENTION**  
CHARGE MAXIMALE 6Kg.

**ACHTUNG**  
MAXIMALE BELASTUNG 6Kg.

**¡ATENCIÓN!**  
CARGA MÁXIMA AUTORIZADA 6Kg.

SRT108M - KR108M

PORTAVALIGIA SPECIFICO - SPECIFIC CASE HOLDER  
 PORTE-VALISE SP CIFIQUE - SPEZIFISCHER KOFFER-TR GER  
 PORTA-EQUIPAJE ESPECIFICO

# PIAGGIO MP3 2006

## 125/250cc

ISTRUZIONI DI MONTAGGIO - MOUNTING INSTRUCTIONS  
 INSTRUCTIONS DE MONTAGE - BAUANLEITUNG - INSTRUCCIONES DE MONTAJE

**7**



**RONDELLA 16x2mm**  
 foro 16,5mm  
 616RONX  
 WASHER Ø6mm  
 RONDELLE Ø6mm  
 SCHEIBE Ø6mm  
 ARANDELA Ø6mm

**Q.TY n.2**

**8**



**RONDELLA 18x20mm**  
 WASHER Ø8x20mm  
 RONDELLE Ø8x20mm  
 SCHEIBE Ø8x20mm  
 ARANDELA Ø8x20mm

**Q.TY n.2**

**9**



**RONDELLA 18x14mm**  
 WASHER Ø8x14mm  
 RONDELLE Ø8x14mm  
 SCHEIBE Ø8x14mm  
 ARANDELA Ø8x14mm

**Q.TY n.4**

**10**



**DADO A.B. M6**  
 BOLT M6  
 ECROU M6  
 MUTTER M6  
 TUERCA M6

**Q.TY n.4**

**11**



**PIASTRA MONOLOCK**  
 Z667M  
 PLATE  
 PLATINE  
 PLATTE  
 PARRILLA

**Q.TY n.1**

**12**



**COPRIFORO**  
 Z621  
 BOLT CAP  
 CACHE TROU  
 STOPLOCK  
 TAPA AGUJERO

**Q.TY n.6**

**13**



**SCHIENALINO**  
 BÄCKREST  
 DOSSÈRET  
 BEIFAHREER-RÜCKENLEHNE  
 RESPALDO

**Q.TY n.1**

**14**



**Z298**  
**MOUSSE PROTETTIVA**  
 PROTECTIVE RUBBER PADS  
 MOUSSE DE PROTECTION  
 SCHUTZGÜMMI  
 ESPUMA ADHESIVA  
 PROTECTORA

**Q.TY n.2**

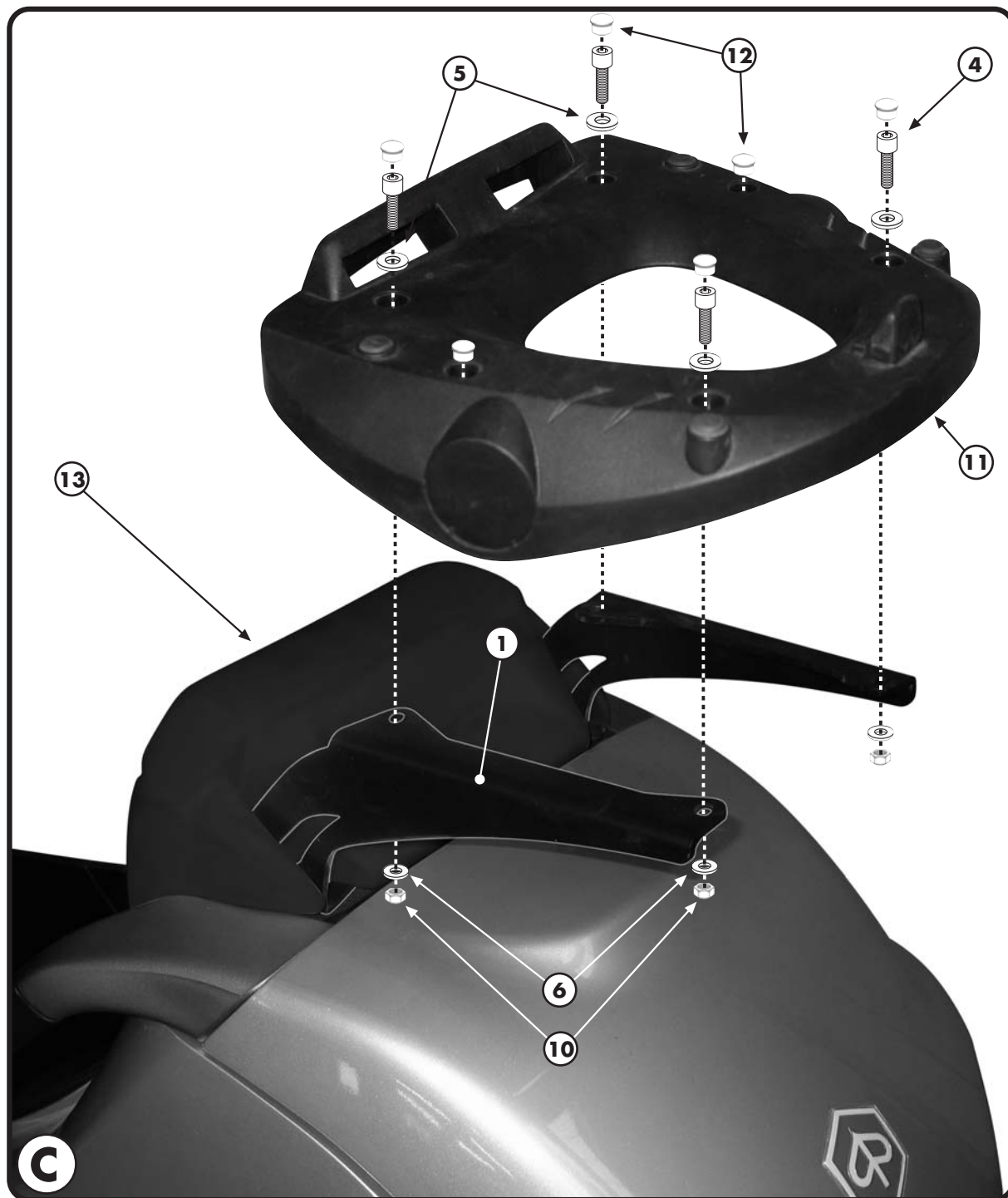
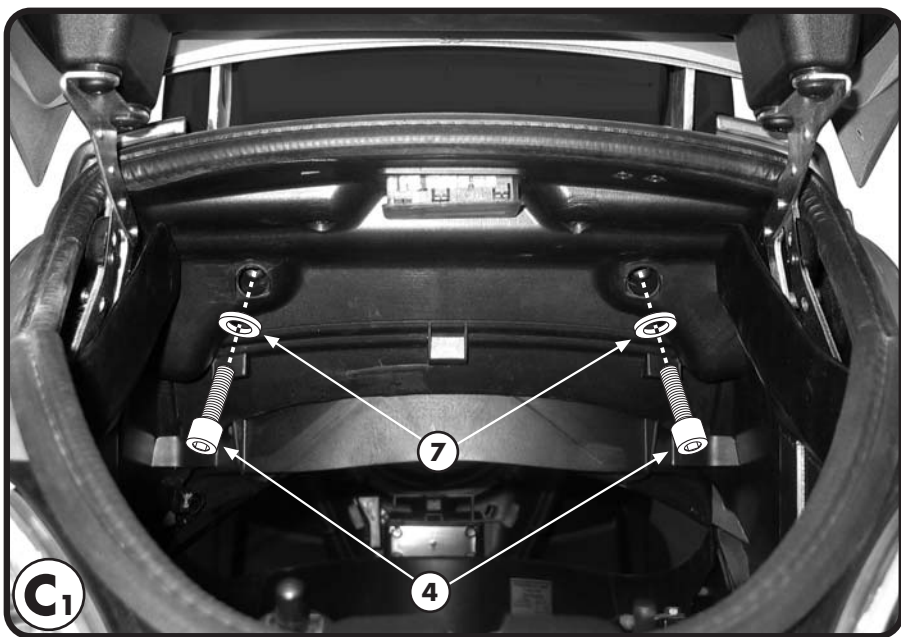

PORTAVALIGIA SPECIFICO - SPECIFIC CASE HOLDER  
 PORTE-VALISE SP CIFIQUE - SPEZIFISCHER KOFFER-TR GER  
 PORTA-EQUIPAJE ESPECCEFICO

**PIAGGIO MP3 2006**  
**125/250cc**

ISTRUZIONI DI MONTAGGIO - MOUNTING INSTRUCTIONS  
 INSTRUCTIONS DE MONTAGE - BAUANLEITUNG - INSTRUCCIONES DE MONTAJE

## I ISTRUZIONI DI MONTAGGIO

1. SMONTARE LO SCHIENALINO ORIGINALE, FOTOGRAFIA A;
2. MONTARE I SUPPORTO N°1 COME INDICATO IN FOTOGRAFIA B;
3. MONTARE LO SCHIENALINO, PARTICOLARE N°13, COME INDICATO IN FOTOGRAFIA C, FACENDO RIFERIMENTO PER IL FISSAGGIO ALLA FOTOGRAFIA C1;
4. MONTARE LA PIASTRA PORTAVALIGIA COME INICATO IN FOTOGRAFIA C;
5. ULTIMARE IL MONTAGGIO CONTROLLANDO CHE TUTTE LE VITI SIANO SERRATE BENE.

**ATTENZIONE:** le protezioni adesive (particolare n°17) sono da utilizzare per proteggere lo sportello posteriore in fase di apertura

## GB MOUNTING INSTRUCTIONS

1. REMOVE THE ORIGINAL BACKREST, PICTURE A;
2. MOUNT THE SUPPORT N° 1 AS SHOWN IN PICTURE B;
3. MOUNT THE BACKREST, PART N° 13, AS SHOWN IN PICTURE C, PAYING ATTENTION TO THE FIXINGS INDICATED IN PICTURE C1;
4. MOUNT THE PLATE AS SHOWN IN PICTURE C;
5. LASTLY CHECK THAT ALL SCREWS HAVE BEEN TIGHTENED.

**ATTENTION:** the protective rubber pads (part n° 17) should be used to protect the door of the rear boot when you open it.

## F INSTRUCTIONS DE MONTAGE

1. DEMONTER LE DOSSERET D'ORIGINE, PHOTO A ;
2. MONTER LES SUPPORTS N° 1 COMME INDIQUE EN PHOTO B ;
3. MONTER LE DOSSERET, PIECE N°13 COMME INDIQUE EN PHOTO C, POUR LA FIXATION, SE REFERER A LA PHOTO C1 ;
4. MONTER LA PLATINE COMME INDIQUE EN PHOTO C ;
5. TERMINER LE MONTAGE EN CONTROLANT LE BON SERRAGE DE TOUTES LES VIS.

**ATTENTION:** les protections adhesives (n°17) doivent etre utilise es pour proteger le capot arriere en position ouverte

## D BAUANLEITUNG

1. MONTIEREN SIE DIE ORIGINAL RÜCKENLEHNE AB, BILD A;
2. MONTIEREN SIE DIE HALTERUNGEN NR. 1 WIE IM BILD B BESCHRIEBEN;
3. MONTIEREN SIE DIE RÜCKENLEHNE, TEIL NR. 13, WIE IM BILD C BESCHRIEBEN, NEHMEN SIE BEZUG AUF DIE HINWEISE VOM BILD C1;
4. MONTIEREN SIE DIE PLATTE WIE IM BILD C BESCHRIEBEN;
5. ZULETZT ÜBERPRÜFEN SIE, DASS ALLE SCHRAUBEN FESTGEZOGEN WURDEN.

**ACHTUNG:** verwenden Sie die Schutzgummis (Teil Nr. 17) um die Abdeckung des hinteren Staufachs beim Öffnen zu schützen.

## ES

## INSTRUCCIONES DE MONTAJE

1. DESMONTAR EL RESPALDO ORIGINAL, IMAGEN A;
2. MONTAR EL SOPORTE N°1 TAL Y COMO SE INDICA EN LA IMAGEN B.
3. MONTAR EL RESPALDO, ARTICULO N° 13, TAL Y COMO SE INDICA EN LA IMAGEN C, FIJANDOSE EN LA IMAGEN C1 PARA LA FIJACION.
4. MONTAR LA PARRILLA PORTAEQUIPAJES TAL Y COMO SE INDICA EN LA IMAGEN C;
5. FINALIZAR EL MONTAJE ASEGURANDOSE QUE TODOS LOS TORNILLOS HAN SIDO APRETADOS CORRECTAMENTE.

**ATENCIÓN:** las gomas protectoras adhesivas (detalle n° 17) se utilizan para proteger la ventanilla trasera durante la apertura