

## Schutzbügel TRIUMPH Tiger 1050 Crash Bar TRIUMPH Tiger 1050

### Montagehinweise

Alle vom Motorrad gelösten Schrauben sind gemäß Herstellerangaben wieder zu montieren, oder mit von SW-MOTECH gelieferten Schrauben zu ersetzen. Falls nicht anderweitig definiert, diese Schrauben nach Tabelle anziehen.

M12	79 Nm
-----	-------

Gegebenenfalls Schrauben mit flüssiger Schraubensicherung einkleben.

Prüfen Sie nach 50 km alle Verbindungen auf festen Sitz.

### Mounting Instructions

SW-MOTECH products should be installed by a qualified, experienced motorcycle technician. If you are unsure of your ability to properly install a product, please have the product installed by your local motorcycle dealer. SW-MOTECH takes no responsibility for damages caused by improper installation.

All screws, bolts and nuts, including all replacement hardware provided by SW-MOTECH, should be tightened to the torque specified in the OEM maintenance manual for your motorcycle. If no torque specifications are provided in the OEM maintenance manual, the following torques may be used:

M12	79 Nm
-----	-------

All screws, bolts and nuts should be checked after driving the first 50 km to ensure that all are tightened to the proper torque.

Medium strength liquid thread-locker (i.e., "Loctite") should be used to secure all screws, bolts and nuts.

SW-MOTECH GmbH & Co. KG  
Bahnhofstrasse 44d  
35282 Rauschenberg  
-Germany-

Tel.: ++ 49 (0) 6425 816 800  
Fax: ++ 49 (0) 6425 816 810

[www.sw-motech.com](http://www.sw-motech.com)

**!** Achtung: gezeigte Verkleidungsteile müssen vor Montage des Schutzbügels demontiert werden. Nachdem der Schutzbügel lose montiert ist, können die Verkleidungsteile beidseitig angebracht werden. Anschließend die Schrauben des Schutzbügels anziehen.

Attention: before assembly, first detach the shown plastic covers. Then fix the crashbar, and loosely attach the plastic covers on both sides. Lastly tighten all the screws of the crashbar.

**!** Achtung: auf der rechten Seite an **Montagepunkt A** Original Unterlegscheibe benutzen.

Attention: use the original washer on the right side at **fixing point A**.

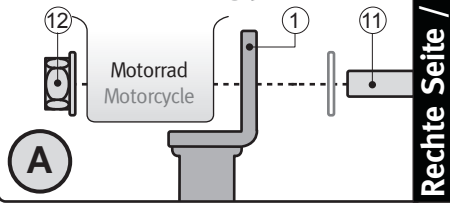

**!** Achtung: auf der rechten Seite an **Montagepunkt B** Original Unterlegscheibe benutzen.

Attention: use the original washer on the right side at **fixing point B**.

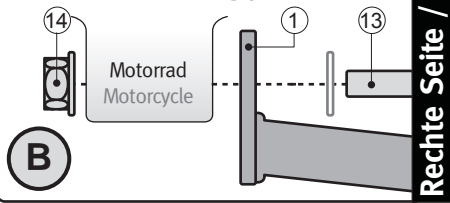

**!** Achtung: auf der rechten Seite an **Montagepunkt C** Original Unterlegscheibe und Distanzbuchse (17) benutzen.

Attention: use the original washer and spacer (17) on the right side at **fixing point C**.

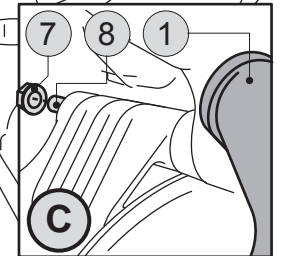
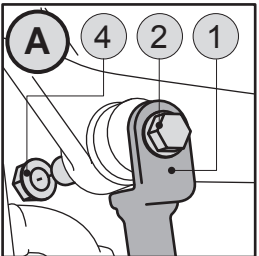
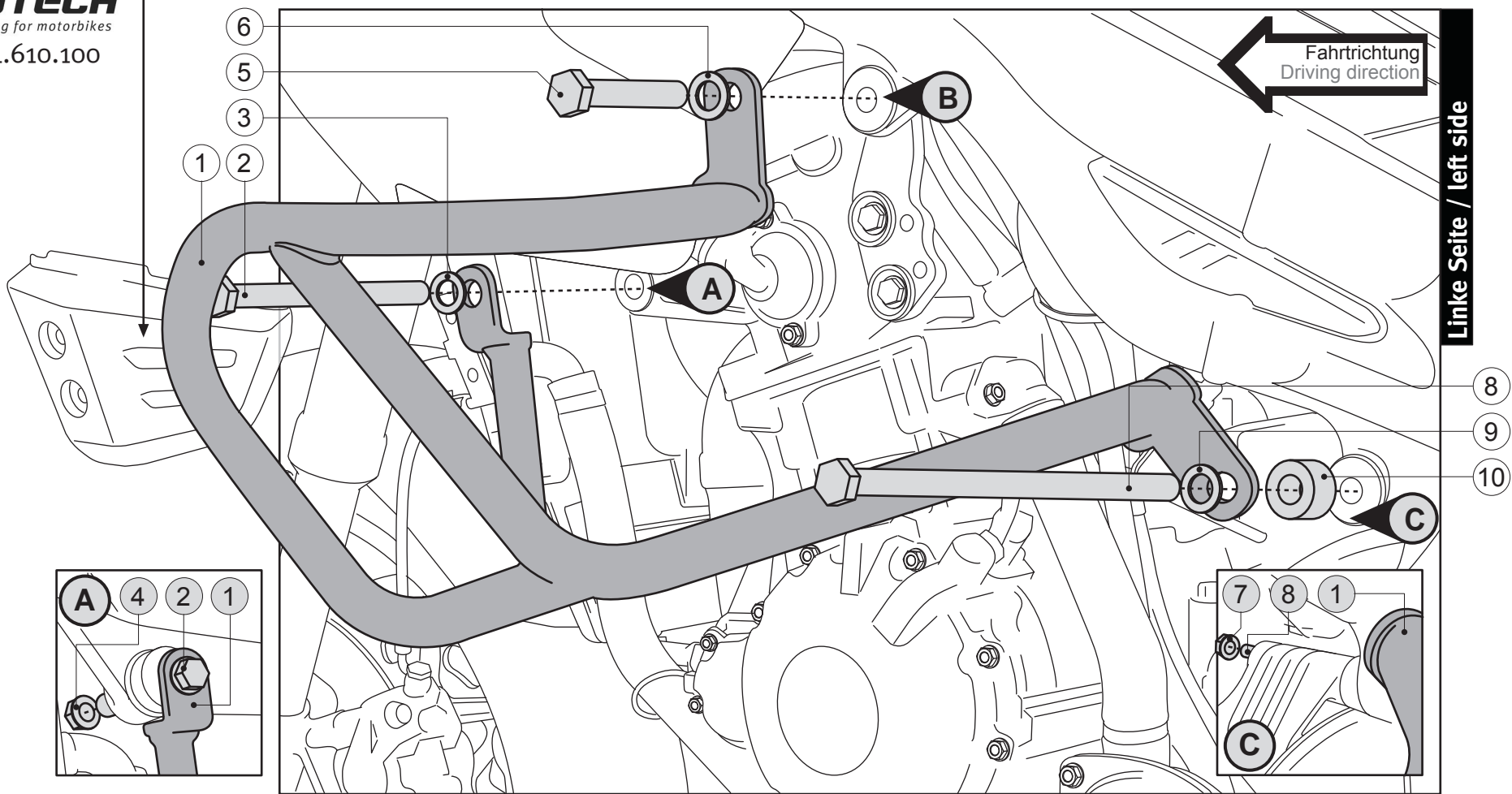
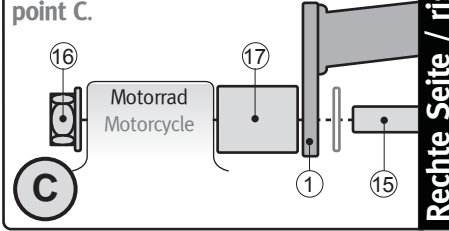

1

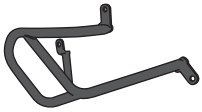
Schutzbügel  
Crash Bar

schwarz/black

SBL.11.610.901/902 oo

Anzahl/ Pcs. 2 (L/R)

2

Sechskantschraube  
Hexagon Screw

A

M12 x 100 DIN 931

Anzahl/ Pcs. 1

5

Sechskantschraube  
Hexagon Screw

B

M12 x 1,25 x 50 DIN 960

Anzahl/ Pcs. 1

8

Sechskantschraube  
Hexagon Screw

C

M12 x 150 DIN 931

Anzahl/ Pcs. 1

11

Sechskantschraube  
Hexagon Screw

A

M12 x 100 DIN 931

Anzahl/ Pcs. 1

13

Sechskantschraube  
Hexagon Screw

B

M12 x 80 DIN 931

Anzahl/ Pcs. 1

15

Sechskantschraube  
Hexagon Screw

C

M12 x 150 DIN 931

Anzahl/ Pcs. 1

3

Unterlegscheibe  
Washer

A 13 DIN 125

Anzahl/ Pcs. 1

6

Unterlegscheibe  
Washer

A 13 DIN 125

Anzahl/ Pcs. 1

9

Unterlegscheibe  
Washer

A 13 DIN 125

Anzahl/ Pcs. 1

12

Mutter mit Bund,  
selbstsichernd  
Lock Nut with Flange

silber/silver

M12 DIN 6927

Anzahl/ Pcs. 1

14

Mutter mit Bund,  
selbstsichernd  
Lock Nut with Flange

silber/silver

M12 DIN 6927

Anzahl/ Pcs. 1

16

Mutter mit Bund,  
selbstsichernd  
Lock Nut with Flange

silber/silver

M12 DIN 6927

Anzahl/ Pcs. 1

4

Mutter mit Bund,  
selbstsichernd  
Lock Nut with Flange

silber/silver

M12 DIN 6927

Anzahl/ Pcs. 1

7

Mutter mit Bund,  
selbstsichernd  
Lock Nut with Flange

silber/silver

M12 DIN 6927

Anzahl/ Pcs. 1

10

Distanzbuchse  
Spacer

Da:25 Di:12,5 h:15

Anzahl/ Pcs. 1

17

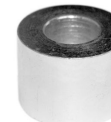
Distanzbuchse  
Spacer

Da:25 Di:12,5 h:17

Anzahl/ Pcs. 1

Linke Seite / left side

Rechte Seite / right side